

Grade : NC3S01

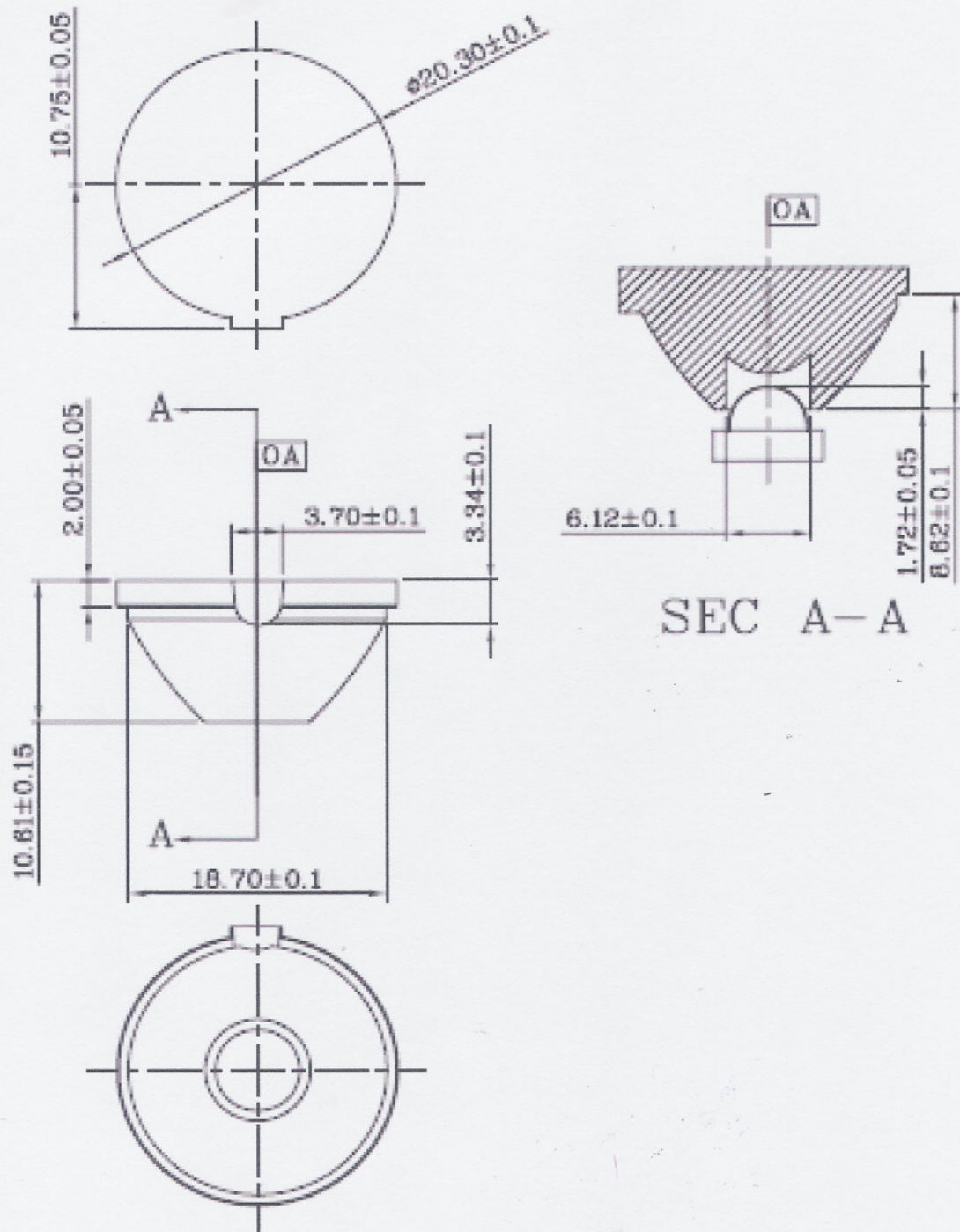

DONGHWA IND CO., LTD.

Grade : HOLDER_N_8.4mm

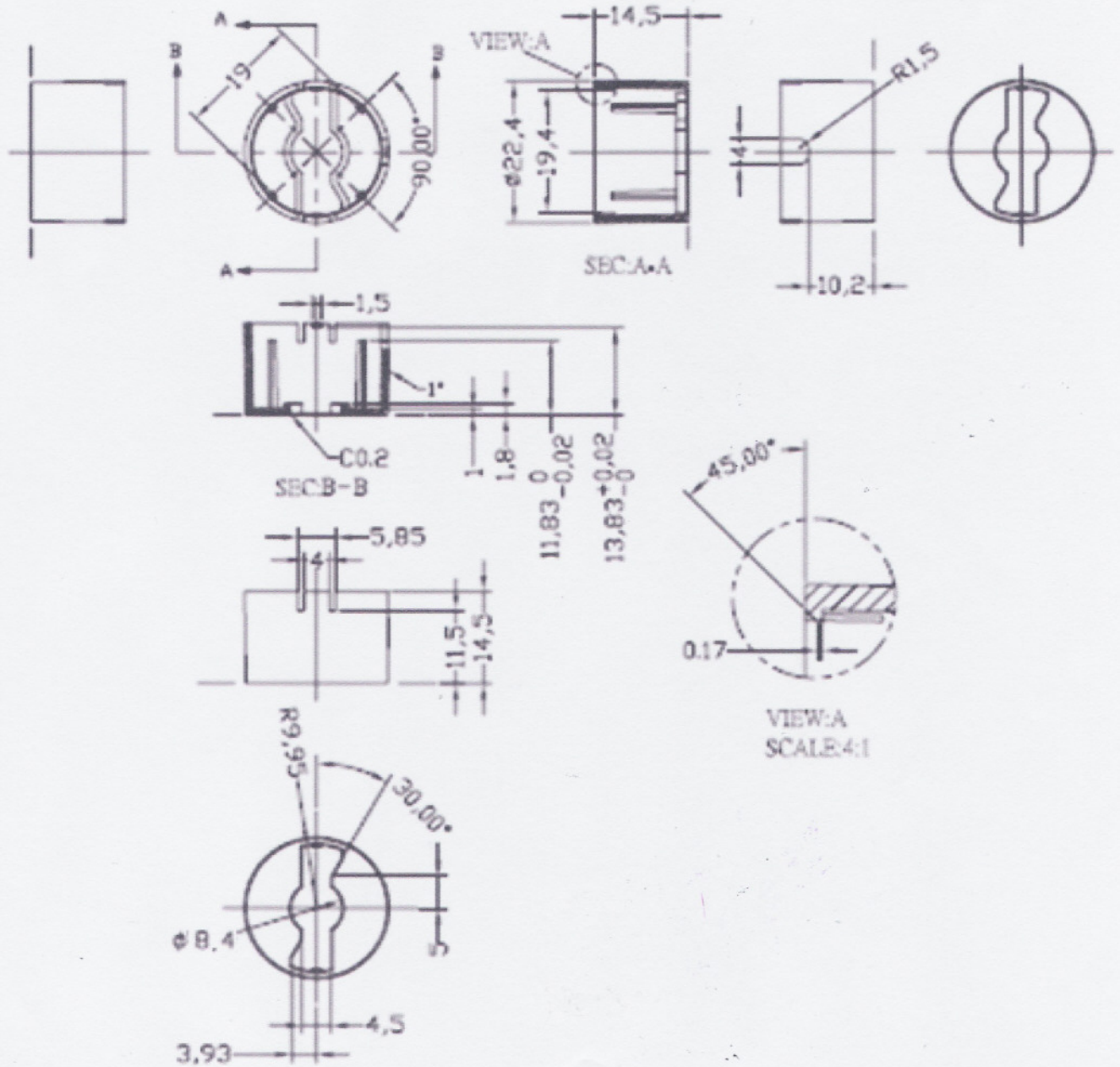

DONGHWA IND CO., LTD.