

Grade : C3S01

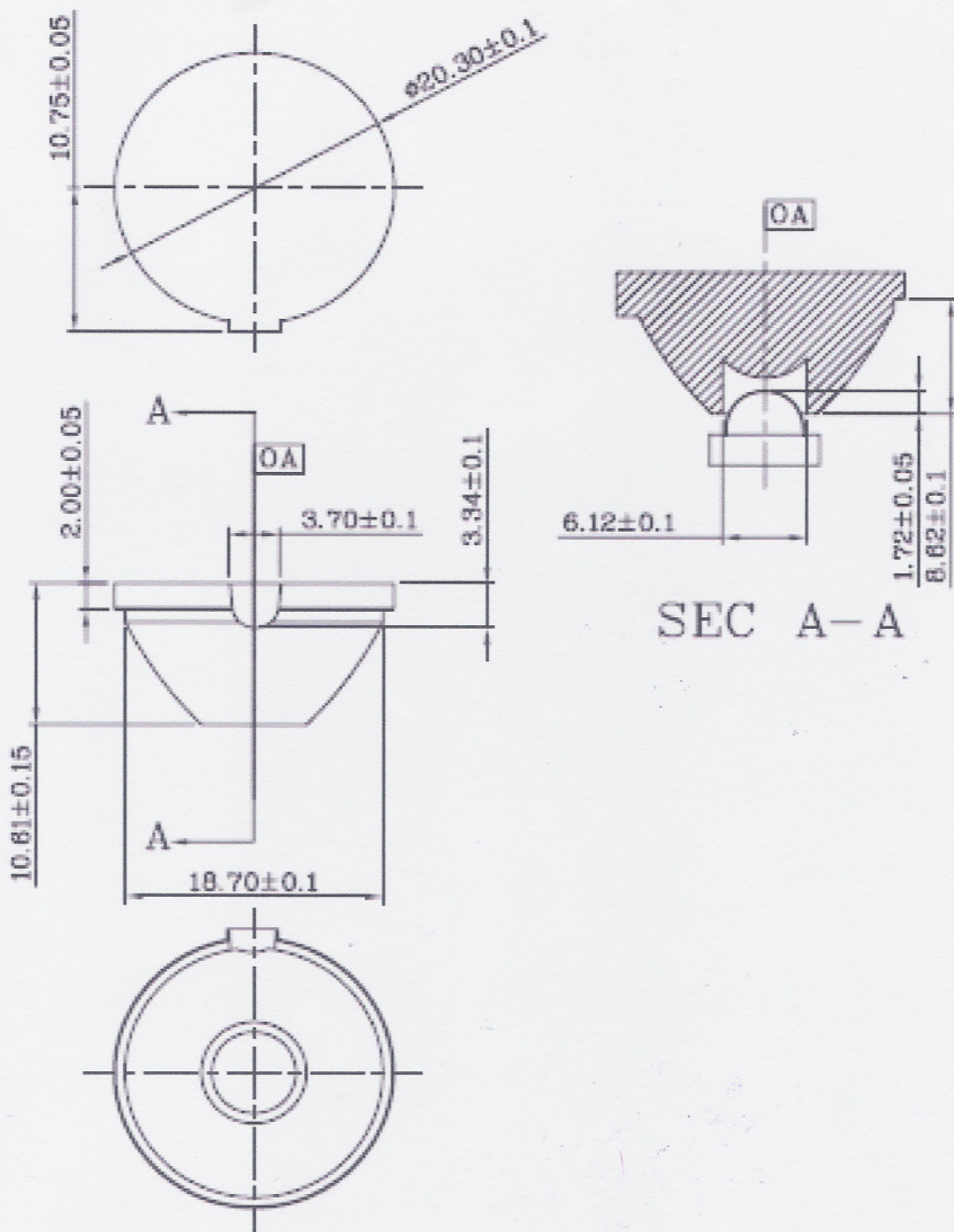

DONGHWA IND CO., LTD.